

# TOSHIBA

*AIR CONDITIONER (MULTI TYPE)*

## Owner's Manual

For wireless remote controller



### Indoor Unit

Model name: \_\_\_\_\_

For commercial use

High-Wall Type

**MMK-UP0071HP-AE, MMK-UP0151HP-AE**

**MMK-UP0091HP-AE, MMK-UP0181HP-AE**

**MMK-UP0121HP-AE, MMK-UP0241HP-AE**

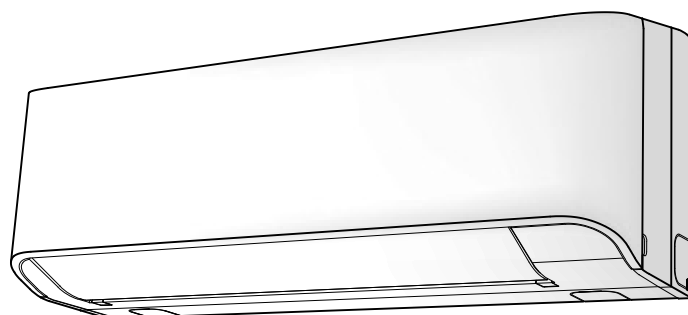

1121250218

Thank you very much for purchasing TOSHIBA Air Conditioner.

Please read this owner's manual carefully before using your Air Conditioner.

- Be sure to obtain the "Owner's manual" and "Installation manual" from constructor (or dealer).
- Request to constructor or dealer
- Please clearly explain the contents of the Owner's manual and hand over it.

#### **NOTE**

This manual describes operations of the indoor unit and the wireless remote controller.

For details of the wired remote controller and the outdoor unit, refer to the operation manual supplied with the outdoor unit. (Keep these manuals carefully.)

### **ADOPTION OF NEW REFRIGERANT**

This Air Conditioner is a new type which adopts a new refrigerant HFC (R410A) instead of the conventional refrigerant R22 in order to prevent destruction of the ozone layer.

According to IEC 60335-1

This appliance is not intended for use by persons (including children) with reduced physical, sensory or mental capabilities, or lack of experience and knowledge, unless they have been given supervision or instruction concerning use of the appliance by a person responsible for their safety. Children should be supervised to ensure that they do not play with the appliance.

According to EN 60335-1

This appliance can be used by children aged from 8 years and above and persons with reduced physical, sensory or mental capabilities or lack of experience and knowledge if they have been given supervision or instruction concerning use of the appliance in a safe way and understand the hazards involved.

Children shall not play with the appliance. Cleaning and user maintenance shall not be made by children without supervision.

---

## Contents

---

1	PRECAUTIONS FOR SAFETY .....	5
2	ACCESSORIES .....	11
3	PARTS NAME.....	11
4	PARTS NAME OF REMOTE CONTROLLER .....	13
5	ADJUSTING CLOCK.....	15
6	LIMITED OPERATION BY GROUP CONTROL.....	16
7	HANDLING THE REMOTE CONTROLLER.....	17
8	HOW TO USE REMOTE CONTROLLER.....	18
9	HINTS FOR ECONOMICAL OPERATION .....	25
10	TEMPORARY OPERATION .....	26
11	MAINTENANCE.....	27
12	TROUBLES AND CAUSES.....	30

Thank you for purchasing this Toshiba air conditioner.

Please read carefully through these instructions that contain important information and ensure that you understand them.

After reading these instructions, be sure to keep them in a safe place together with the Installation Manual supplied with your product.

**Generic Denomination: Air Conditioner**





**Definition of Qualified Installer or Qualified Service Person**

The air conditioner must be installed, maintained, repaired and removed by a qualified installer or qualified service person. When any of these jobs is to be done, ask a qualified installer or qualified service person to do them for you.

A qualified installer or qualified service person is an agent who has the qualifications and knowledge described in the table below.

Agent	Qualifications and knowledge which the agent must have
Qualified installer	<ul style="list-style-type: none"> <li>• The qualified installer is a person who installs, maintains, relocates and removes the air conditioners made by Toshiba Carrier Corporation. He or she has been trained to install, maintain, relocate and remove the air conditioners made by Toshiba Carrier Corporation or, alternatively, he or she has been instructed in such operations by an individual or individuals who have been trained and is thus thoroughly acquainted with the knowledge related to these operations.</li> <li>• The qualified installer who is allowed to do the electrical work involved in installation, relocation and removal has the qualifications pertaining to this electrical work as stipulated by the local laws and regulations, and he or she is a person who has been trained in matters relating to electrical work on the air conditioners made by Toshiba Carrier Corporation or, alternatively, he or she has been instructed in such matters by an individual or individuals who have been trained and is thus thoroughly acquainted with the knowledge related to this work.</li> <li>• The qualified installer who is allowed to do the refrigerant handling and piping work involved in installation, relocation and removal has the qualifications pertaining to this refrigerant handling and piping work as stipulated by the local laws and regulations, and he or she is a person who has been trained in matters relating to refrigerant handling and piping work on the air conditioners made by Toshiba Carrier Corporation or, alternatively, he or she has been instructed in such matters by an individual or individuals who have been trained and is thus thoroughly acquainted with the knowledge related to this work.</li> <li>• The qualified installer who is allowed to work at heights has been trained in matters relating to working at heights with the air conditioners made by Toshiba Carrier Corporation or, alternatively, he or she has been instructed in such matters by an individual or individuals who have been trained and is thus thoroughly acquainted with the knowledge related to this work.</li> </ul>
Qualified service person	<ul style="list-style-type: none"> <li>• The qualified service person is a person who installs, repairs, maintains, relocates and removes the air conditioners made by Toshiba Carrier Corporation. He or she has been trained to install, repair, maintain, relocate and remove the air conditioners made by Toshiba Carrier Corporation or, alternatively, he or she has been instructed in such operations by an individual or individuals who have been trained and is thus thoroughly acquainted with the knowledge related to these operations.</li> <li>• The qualified service person who is allowed to do the electrical work involved in installation, repair, relocation and removal has the qualifications pertaining to this electrical work as stipulated by the local laws and regulations, and he or she is a person who has been trained in matters relating to electrical work on the air conditioners made by Toshiba Carrier Corporation or, alternatively, he or she has been instructed in such matters by an individual or individuals who have been trained and is thus thoroughly acquainted with the knowledge related to this work.</li> <li>• The qualified service person who is allowed to do the refrigerant handling and piping work involved in installation, repair, relocation and removal has the qualifications pertaining to this refrigerant handling and piping work as stipulated by the local laws and regulations, and he or she is a person who has been trained in matters relating to refrigerant handling and piping work on the air conditioners made by Toshiba Carrier Corporation or, alternatively, he or she has been instructed in such matters by an individual or individuals who have been trained and is thus thoroughly acquainted with the knowledge related to this work.</li> <li>• The qualified service person who is allowed to work at heights has been trained in matters relating to working at heights with the air conditioners made by Toshiba Carrier Corporation or, alternatively, he or she has been instructed in such matters by an individual or individuals who have been trained and is thus thoroughly acquainted with the knowledge related to this work.</li> </ul>

■ Warning indications on the air conditioner unit

Warning indication	Description				
 <table border="1" data-bbox="363 363 666 552"> <tr> <td colspan="2" style="text-align: center;"><b>WARNING</b></td> </tr> <tr> <td colspan="2"><b>ELECTRICAL SHOCK HAZARD</b> Disconnect all remote electric power supplies before servicing.</td> </tr> </table>	<b>WARNING</b>		<b>ELECTRICAL SHOCK HAZARD</b> Disconnect all remote electric power supplies before servicing.		<p><b>WARNING</b></p> <p><b>ELECTRICAL SHOCK HAZARD</b> Disconnect all remote electric power supplies before servicing.</p>
<b>WARNING</b>					
<b>ELECTRICAL SHOCK HAZARD</b> Disconnect all remote electric power supplies before servicing.					
 <table border="1" data-bbox="363 615 666 804"> <tr> <td colspan="2" style="text-align: center;"><b>WARNING</b></td> </tr> <tr> <td colspan="2">Moving parts. Do not operate unit with grille removed. Stop the unit before the servicing.</td> </tr> </table>	<b>WARNING</b>		Moving parts. Do not operate unit with grille removed. Stop the unit before the servicing.		<p><b>WARNING</b></p> <p>Moving parts. Do not operate unit with grille removed. Stop the unit before the servicing.</p>
<b>WARNING</b>					
Moving parts. Do not operate unit with grille removed. Stop the unit before the servicing.					
 <table border="1" data-bbox="363 871 666 1060"> <tr> <td colspan="2" style="text-align: center;"><b>CAUTION</b></td> </tr> <tr> <td colspan="2">High temperature parts. You might get burned when removing this panel.</td> </tr> </table>	<b>CAUTION</b>		High temperature parts. You might get burned when removing this panel.		<p><b>CAUTION</b></p> <p>High temperature parts. You might get burned when removing this panel.</p>
<b>CAUTION</b>					
High temperature parts. You might get burned when removing this panel.					
 <table border="1" data-bbox="363 1127 666 1316"> <tr> <td colspan="2" style="text-align: center;"><b>CAUTION</b></td> </tr> <tr> <td colspan="2">Do not touch the aluminum fins of the unit. Doing so may result in injury.</td> </tr> </table>	<b>CAUTION</b>		Do not touch the aluminum fins of the unit. Doing so may result in injury.		<p><b>CAUTION</b></p> <p>Do not touch the aluminum fins of the unit. Doing so may result in injury.</p>
<b>CAUTION</b>					
Do not touch the aluminum fins of the unit. Doing so may result in injury.					
 <table border="1" data-bbox="363 1383 666 1572"> <tr> <td colspan="2" style="text-align: center;"><b>CAUTION</b></td> </tr> <tr> <td colspan="2"><b>BURST HAZARD</b> Open the service valves before the operation, otherwise there might be the burst.</td> </tr> </table>	<b>CAUTION</b>		<b>BURST HAZARD</b> Open the service valves before the operation, otherwise there might be the burst.		<p><b>CAUTION</b></p> <p><b>BURST HAZARD</b> Open the service valves before the operation, otherwise there might be the burst.</p>
<b>CAUTION</b>					
<b>BURST HAZARD</b> Open the service valves before the operation, otherwise there might be the burst.					

# 1 PRECAUTIONS FOR SAFETY

## DANGER

- Do not attempt to install this unit by yourself. This unit requires qualified installer.
- Do not attempt to repair the unit by yourself. This unit has no components which you can repair.
- Opening or removing the cover will expose you to dangerous voltage.
- Turning off the power supply will not prevent potential electric shock.



The manufacturer shall not assume any liability for the damage caused by not observing the description of this manual.

## WARNING

### General

- Carefully read Owner's Manual before starting the air conditioner. There are many important things to keep in mind for daily operation.
- Ask for installation to be performed by the dealer or a professional. Only a qualified installer (\*1) is able to install an air conditioner. If a non-qualified person installs an air conditioner, it may result in problems such as fire, electric shock, injury, water leakage, noise and vibration.
- Do not use any refrigerant different from the one specified for complement or replacement. Otherwise, abnormally high pressure may be generated in the refrigeration cycle, which may result in a failure or explosion of the product or an injury to your body.
- Places where the operation sound of the outdoor unit may cause a disturbance. (Especially at the boundary line with a neighbour, install the air conditioner while considering the noise.)
- This appliance is intended to be used by expert or trained users in shops, in light industry, or for commercial use by lay persons.

### Transportation and storage

- To transport the air conditioner, wear shoes with protective toe caps, protective gloves, and other protective clothing.
- To transport the air conditioner, do not take hold of the bands around the packing carton. You may injure yourself if the bands should break.
- Before stacking the packing cartons for storage or transportation, heed the precautions written on the packing cartons. Failure to heed the precautions may cause the stack to collapse.
- The air conditioner must be transported in stable condition. If any part of the product broken, contact your dealer.

- When the air conditioner must be transported by hand, carry it by two or more people.

## Installation

- Only a qualified installer (\*1) or qualified service person (\*1) is allowed to carry out the electrical work of the air conditioner. Under no circumstances must this work be done by an unqualified individual since failure to carry out the work properly may result in electric shocks and/or electrical leaks.
- After the installation work has been completed, have the installer explain about the circuit breaker positions. In the event that trouble has occurred in the air conditioner, set the circuit breaker to the OFF position, and contact a qualified service person (\*1).
- If the unit is installed in a small room, take appropriate measures to prevent the refrigerant from exceeding the limit concentration even if it leaks. Consult the dealer from whom you purchased the air conditioner when you implement the measures. Accumulation of highly concentrated refrigerant may cause an oxygen deficiency accident.
- Do not install the air conditioner in a location that may be subject to a risk of exposure to a combustible gas. If a combustible gas leaks and becomes concentrated around the unit, a fire may occur.
- Use the company-specified products for the separately purchased parts. Use of non-specified products may result in fire, electric shock, water leakage or other trouble. Have the installation performed by a professional.
- Confirm that earthing is performed correctly.

## Operation

- Before opening the front panel of the indoor unit or service panel of the outdoor unit, set the circuit breaker to the OFF position. Failure to set the circuit breaker to the OFF position may result in electric shocks through contact with the interior parts. Only a qualified installer (\*1) or qualified service person (\*1) is allowed to remove the front panel of the indoor unit or service panel of the outdoor unit and do the work required.
- Inside the air conditioner are high-voltage areas and rotating parts. Due to the danger of electric shocks or of your fingers or physical objects becoming trapped in the rotating parts, do not remove the front panel of the indoor unit or service panel of the outdoor unit. When work involving the removal of these parts is required, contact a qualified installer (\*1) or qualified service person (\*1).
- Do not move or repair any unit by yourself. Since there is high voltage inside the unit, you may get electric shock when the cover and main unit is removed.
- Use of a stand more than 50 cm high to clean the filter of the indoor unit or to carry out other such jobs constitutes working at heights. Due to the danger of falling off the stand and injuring yourself while working at heights, this kind of work should not be done by unqualified individuals. When this kind of work must be carried out, do not do it yourself but ask a qualified installer (\*1) or qualified service person (\*1) to do it for you.

- Do not touch the aluminum fin of the outdoor unit. You may injure yourself if you do so. If the fin must be touched, do not touch it yourself but contact a qualified installer (\*1) or qualified service person (\*1).
- Do not climb onto or place objects on top of the outdoor unit. You may fall or the objects may fall off of the outdoor unit and result in injury.
- Do not place any combustion appliance in a place where it is directly exposed to the wind of air conditioner, otherwise it may cause imperfect combustion.
- When the air conditioner is operated with a combustion appliance in the same place, ventilate the room sufficiently. Poor ventilation causes oxygen shortage.
- When the air conditioner is used in a closed room, sufficiently ventilate the room. Poor ventilation causes oxygen shortage.
- Do not expose your body to cool air directly for a long time and do not cool yourself excessively. Doing so may result in deteriorated physical condition and ill health.
- Do not insert your finger or a stick into the air intake or discharge. Doing so may result injury as the fan is rotating at high speed inside the unit.
- Consult the shop where you purchased the air conditioner if air conditioning (cooling and heating) is not performed properly as a refrigerant leakage may be the cause. Confirm the repair details with a qualified service person (\*1) when the repair includes additional charging of the refrigerant.
- Stop running the air conditioner and turn off the breaker before cleaning. Otherwise, injury may result as the fan is rotating at high speed inside the unit.

## Repairs

- If there is any kind of trouble (such as when an error display has appeared, there is a smell of burning, abnormal sounds are heard, the air conditioner fails to cool or heat or water is leaking) has occurred in the air conditioner, do not touch the air conditioner yourself but set the circuit breaker to the OFF position, and contact a qualified service person (\*1). Take steps to ensure that the power will not be turned on (by marking "out of service" near the circuit breaker, for instance) until qualified service person (\*1) arrives. Continuing to use the air conditioner in the trouble status may cause mechanical problems to escalate or result in electric shocks or other trouble.
- If the fan grille is damaged, do not approach the outdoor unit but set the circuit breaker to the OFF position, and contact a qualified service person (\*1) to have the repairs done. Do not set the circuit breaker to the ON position until the repairs are completed.
- If there is a danger of the indoor unit's falling, do not approach the indoor unit but set the circuit breaker to the OFF position, and contact a qualified installer (\*1) or a qualified service person (\*1) to refit the unit. Do not set the circuit breaker to the ON position until the unit has been refitted.



- If there is a danger of the outdoor unit's toppling over, do not approach the outdoor unit but set the circuit breaker to the OFF position, and contact a qualified installer (\*1) or a qualified service person (\*1) to have the improvements or refitting done. Do not set the circuit breaker to the ON position until the improvements or refitting is completed.
- Do not customize the unit. Doing so may result in fire, electric shock or other trouble.

### Relocation

- When the air conditioner is to be relocated, do not relocate it yourself but contact a qualified installer (\*1) or a qualified service person (\*1). Failure to relocate the air conditioner properly may result in electric shocks and/or a fire.

---

## CAUTION

---

### To disconnect the appliance from the mains supply.

- This appliance must be connected to the mains by means of a switch with a contact separation of at least 3 mm.

### The installation fuse (all types can be used) must be used for the power supply line of this air conditioner.

### Installation

- Certainly lay the drain hose for perfect draining. Bad drainage may cause flooding in the house and getting furniture wet.
- Connect the air conditioner to an exclusive power supply of the rated voltage, otherwise the unit may break down or cause a fire.
- Confirm that the outdoor unit are fixed on the base. Otherwise, falling down of the units or other accidents may occur.

### Operation

- Do not use this air conditioner for special purpose such as preserving food, precision instruments, art objects, breeding animals, car, vessel.
- Do not touch any switches with wet finger, otherwise you may get an electric shock.
- If the air conditioner will not be used for a considerably long time, turn off the main switch or the circuit breaker, for safety.
- To make the air conditioner operate in its original performance, operate it within the range of the operating temperature specified in the instructions. Otherwise it may cause a malfunction, or water leak from the unit.
- Prevent any liquid from falling into the remote controller. Do not spill juice, water or any kind of liquid.
- Do not wash the air conditioner. Doing so may result in electric shock.
- Check whether the installation base and other equipment have become deteriorated after being used for a long time. Leaving them such condition may result in the unit's falling down and causing injury.









- Do not leave flammable sprays or other flammable materials near the air conditioner, and do not spray flammable aerosol directly to the air conditioner. They may catch fire.
- Stop running the air conditioner and turn off the breaker before cleaning. Otherwise, injury may result as the fan is rotating at high speed inside the unit.
- Ask for cleaning of the air conditioner to be performed by the dealer. Cleaning the air conditioner in an improper manner may cause damage to plastic parts, insulation failure of electric parts and result in a malfunction. In the worst case, it may result in water leakage, electric shock, smoke emission and fire.
- Do not put a water container such as a vase on the unit. Water intrusion into the unit may occur and it may cause deterioration of electric insulation and result in electric shock.
- Do not wash air conditioners with pressure washers. Electric leakage may cause electric shocks or fires.

---

(\*1) Refer to the "Definition of Qualified Installer or Qualified Service Person."

■ Information on the transportation, handling and storage of the carton

◆ Examples of indication on the carton

Symbol	Description	Symbol	Description
	Keep dry		Do not drop
	Fragile		Do not lay down
 7 cartons	Stacking height (8 cartons can be stacked in this case)		Do not walk on this carton
	This side up		Do not step
	Handle with care		

Other cautions	Description
 <div style="border: 1px solid black; padding: 5px; margin-left: 10px;"> <p><b>Caution</b></p> <p>Injury possibility. Don't handle with packing band, or may get injured in case of broken band.</p> </div>	<p><b>CAUTION</b></p> <p>Injury possibility. Don't handle with packing band, or may get injured in case of broken band.</p>

## 2 ACCESSORIES

### Remote controller

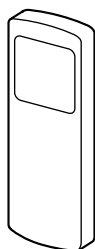

### Remote controller holder



### Batteries (two)

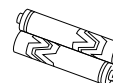

## 3 PARTS NAME

### ■ Indoor unit

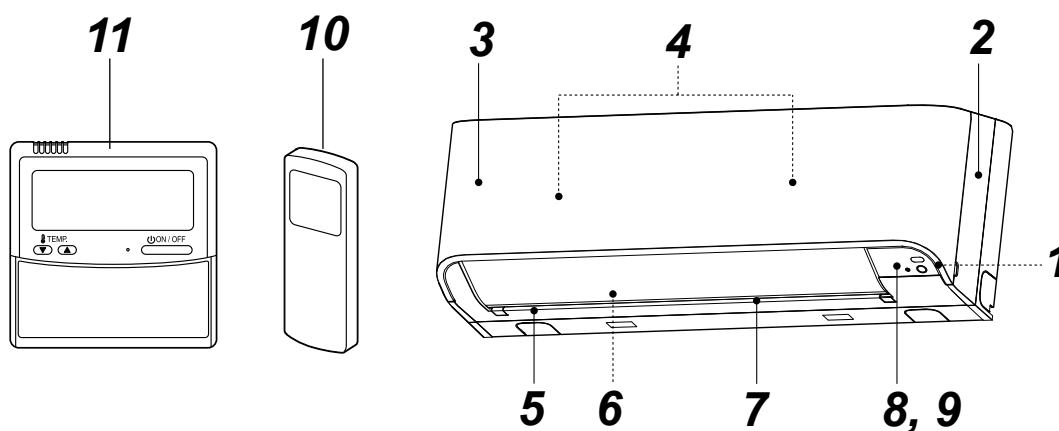

**1** Room temperature sensor

**2** Front panel

**3** Air inlet grille

**4** Air filter

**5** Air outlet

**6** Horizontal airflow louver

**7** Vertical airflow louver

**8** Display panel

**9** Infrared signal receiver

**10** Remote controller (wireless)

**11** Remote controller (wired, sold separately)

## ■ Names and functions of indicators and controls on indoor unit

### Display panel

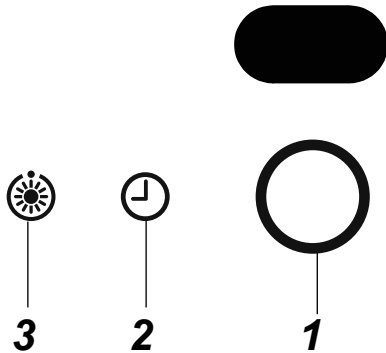

The operating conditions are indicated below.

#### 1 OPERATION (White)

This lamp goes on during operation.

#### 2 TIMER (White)

This lamp goes on white the timer reserved.

#### NOTE

In case of timer setting by wired remote controller, TIMER lamp does not light.

In case of group control, TIMER lamp goes on header unit only. (see "6 LIMITED OPERATION BY GROUP CONTROL")

#### 3 Preheat/Defrost (White)

This lamp lights up when the power is turned on or right after heating operation starts or during defrost operation.

## ⚠ CAUTION

#### • Disagreement in operation mode

If you select AUTOMATIC OPERATION in a model with no auto-changeover (cooling/ heating) control setting or if you select HEAT in a Cool Only model, an alarm sound (pi, pi) from the air conditioner due to disagreement in operation mode. Change the operation mode with the MODE button on the wireless remote controller. This disagreement indication cannot be deleted by the wired remote controller.

- When local prohibition is set by the central control from other equipment, no signal is received even if the remote controller button is pressed. However, a signal of START/STOP button is accepted. (An alarm sound "pi" arises intermittently five times.)

#### TEMPORARY operation

If you misplace or lose the wireless remote controller or its batteries are exhausted, push the [RESET] button.

- Push the [RESET] button to start the air conditioner.  
Push this button once again to stop it.

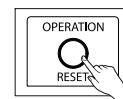
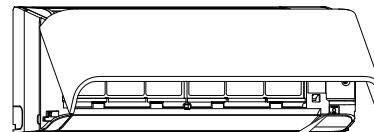

OPERATION/  
RESET Button

# 4 PARTS NAME OF REMOTE CONTROLLER

## ■ Wireless remote controller and its functions

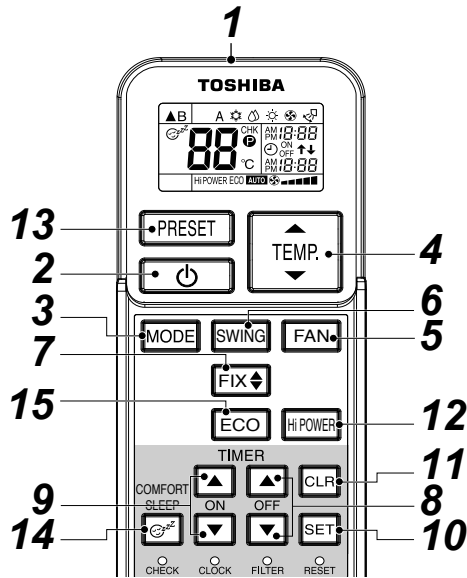

### 1 Infrared signal emitter

Transmits a signal to the indoor unit.

### 2 START/STOP button

Press the button to start operation.  
(A receiving beep is heard.)  
Press the button again to stop operation.  
(A receiving beep is heard.)  
If no receiving sound is heard from the indoor unit,  
press the button twice.

### 3 Mode select button (MODE)

Press this button to select a mode.  
Each time you press the button, a mode is selected in  
a sequence that goes from A : Auto, : Cool,  
 : Dry, : Heat, : Fan only, and back to A.  
(A receiving beep is heard.)

### 4 Temperature button

.....The set temperature is increased up to  
30°C.  
 .....The set temperature is dropped down to  
20°C. (A receiving beep is heard.)

### 5 Fan speed button (FAN)

Press this button to select fan speed.  
When you select AUTO, the fan speed is  
automatically adjusted according to the room  
temperature.

You can also manually select the desired fan speed  
from among five settings.

(LOW , LOW+ , MED ,  
MED+ , HIGH )  
(A receiving beep is heard.)

### 6 Auto louver button (SWING)

Press this button to swing the louver.  
(A receiving beep is heard.)  
Press the SWING button to stop the louver  
swinging.  
(A receiving beep is heard.)

### 7 Set louver button (FIX)

Press this button to adjust the airflow direction.  
(A receiving beep is heard.) While this button is kept  
depressed, the receiving tone continuously sounds.

### 8 Off timer button (OFF)

Press this button to set the OFF timer.

### 9 On timer button (ON)

Press this button to set the ON timer.

### 10 Reserve button (SET)

Press this button to reserve time settings.  
(A receiving beep is heard.)

### 11 Cancel button (CLR)

Press this button to cancel ON timer and OFF timer.  
(A receiving beep is heard.)

### 12 High power button (Hi POWER)

Press this button to start the high power operation.  
This function is not operated group control.

### 13 PRESET button

Press this button to change the operation mode to  
the preferred operation mode memorized previously.  
To memorize the operation mode, press this button  
for at least 3 seconds during the preferred operation  
mode.  
 is displayed and the operation mode is  
memorized.

### 14 COMFORT SLEEP button

Press this button to start the OFF timer operation  
that automatically adjusts the room temperature and  
the fan speed.  
You can select the OFF timer time from four  
durations (1, 3, 5 or 9 hours).  
During group control operation, the set temperature  
and the fan speed are not automatically adjusted.  
Only off timer function is activated.

### 15 ECO button (ECO)

Press this button to start ECO operation.  
Pressing this button again will restore normal  
operation.

## ■ Names and functions of indications on wireless remote controller

### Display

All indications, except for clock time indication, are indicated by pressing the START/STOP  button.

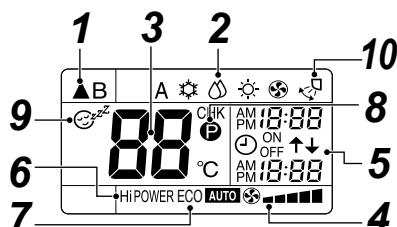

- In the illustration, all indications are indicated for explanation.

During operation, only the relevant indications will be indicated on the remote controller.

#### 1 Transmission mark

This transmission mark (▲) indicates when the remote controller transmits signals to the indoor unit.

#### 2 Mode display

Indicates the current operation mode. (A : Auto, ☀ : Cool, 💧 : Dry, ☀ : Heat, 🌀 : Fan only)

#### 3 Temperature display

Indicates the temperature setting (17°C to 30°C).

When you set the operating mode to 🌀 : Fan only, no temperature setting is indicated.

#### 4 FAN speed display

Indicates the selected fan speed. AUTO or one of five fan speed levels (LOW ■, LOW+ ■■■, MED ■■■■, MED+ ■■■■■, HIGH ■■■■■■) can be indicated.

Indicates **AUTO** when the operating mode is 💧 : Dry.

#### 5 TIMER and clock time display

The time set for timer operation or clock time is indicated.

The present time is always indicated except for TIMER operation.

#### 6 Hi POWER display

Indicates when the high power operation starts. Press the Hi POWER button to start and press it again to stop the operation.

#### 7 ECO display

Indicated during the ECO operation.

#### 8 (PRESET) display

Indicated when memorizing the preferred operation mode or when it has been memorized.

Also, this icon is indicated when the memorized preferred operation is displayed.

#### 9 (COMFORT SLEEP) display

Indicated during the OFF timer operation that automatically adjusts the room temperature and the fan speed. Each time you press the COMFORT SLEEP button, the display changes in the sequence of 1h, 3h, 5h, and 9h.

#### 10 Swing display

Indicated during the swinging operation where the horizontal louver automatically moves up and down.

### NOTE

When both wired remote controller and wireless remote controller are used, display on the screen of wireless remote controller may differ from the actual operation in some cases.

## ■ Preparation and check before use

#### 1. Loading Batteries

- Remove the battery cover.
- Insert 2 new batteries (R03 [AAA]) following the (+) and (-) positions.

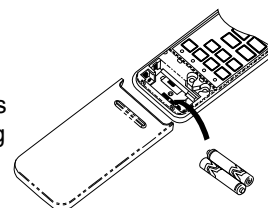

#### 2. Removing Batteries

- Remove the battery cover.
- Remove the 2 used batteries.

### Batteries

- To replace the batteries, use two new batteries (R03 [AAA]).
- In normal use, the batteries will last about one year.
- Replace the batteries if there is no receiving beep from the indoor unit or when the air conditioner cannot be operated using the remote controller.
- To avoid malfunctions by battery leakage, remove the batteries when not using the remote controller for more than one month.
- Please dispose of the used batteries according to the local regulation.

# 5 ADJUSTING CLOCK

## Setting the clock



Before you start operating the air conditioner, set the clock of the remote controller using the procedures given in this section. The clock panel on the remote controller will indicate the time regardless of whether the air conditioner is in use or not.

### Initial setting

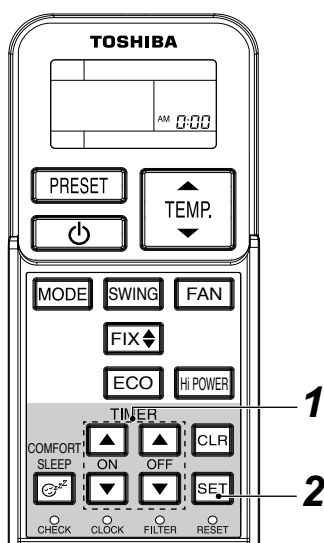
When batteries are inserted in the remote controller the clock panel will indicate AM 0:00 and will flash.



#### 1 TIMER or button

Press the TIMER  or  button to set the current time.  
 Each press of the TIMER button changes the time in one minute steps.  
 Pressing the TIMER button continually changes the time in ten minute steps.

#### 2 SET button

Press the SET  button.  
 The current time is indicated and the clock starts.

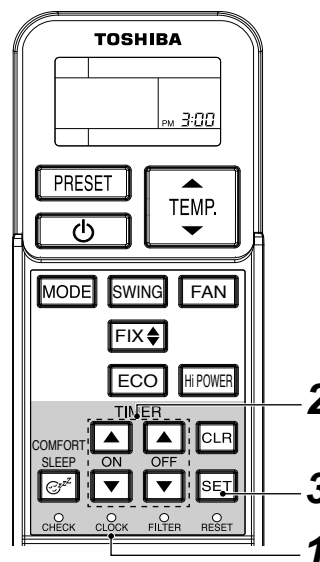

### Clock adjusting



#### 1 CLOCK button

Press the CLOCK  by tip of a pencil.  
 The CLOCK display flashes.

#### 2 TIMER or button

Press the TIMER  or  button to set the current time.  
 Each press of the TIMER button changes the time by one minute.  
 Pressing the TIMER button continually changes the time by ten minutes.

#### 3 SET button

Press the SET  button.  
 The current time is indicated and the clock starts.



## 6 LIMITED OPERATION BY GROUP CONTROL

### NOTE

Group control: Operate air conditioners in more than one system in same time.

Header indoor unit: The representative unit during group control. Receive commands from wired remote controller and transmit the commands to follower units.

(Header indoor unit is indoor unit that receives START/STOP signal from the wireless remote control.)

Follower indoor unit: Indoor units other than the Header unit are called follower unit.

A wired remote controller (separately available) is required for the group control.

### ▼ Example of group combination

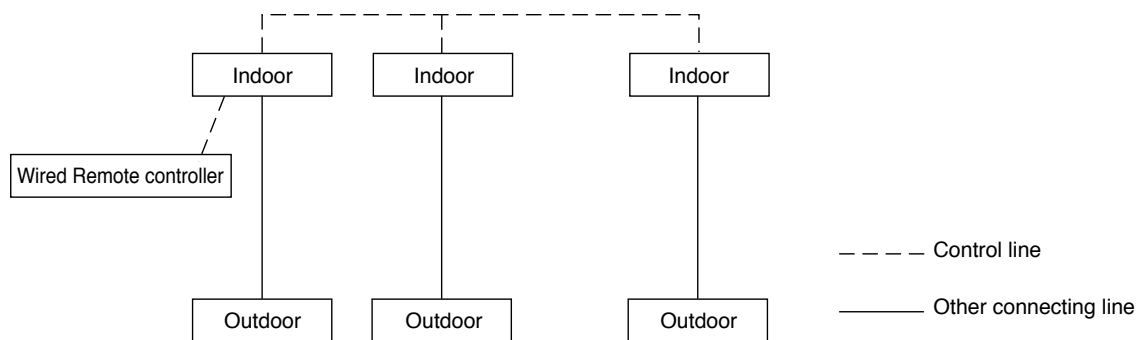

### ⚠ CAUTION

When using indoor unit in group control,

#### 1. Hi POWER operation will not function.

When Hi POWER is transmitted from wireless remote controller the receiving sound will be heard from the indoor unit and display on the wireless remote controller will also change. However, the indoor unit does not operate Hi POWER operation. Restore the display on the wireless remote controller pushing Hi POWER button.

#### 2. COMFORT SLEEP

When COMFORT SLEEP is transmitted from wireless remote controller, the receiving sound will be heard from the indoor unit and the display on the wireless remote controller will also be changed as same as Hi POWER operation. However, the set temperature and the fan speed will not be automatically adjusted. Only off timer function is activated.

#### 3. Units other than the Header unit cannot be operated with remote controller and the TEMPORARY operation.

When operating air conditioner with wireless remote controller transmission should be sent to the Header unit.

Header and follower indoor units are decided through address setting upon installation. Follower unit will not receive any signals from wireless remote controller.

Air conditioner will not work even if the [RESET] button on the follower unit is pressed.

(Some Follower units may receive SWING and FIX, but these operations are performed only on the unit that received the signal.)

(When wireless remote controller is used, only the Header unit receives SWING signal. If the SWING signal is transmitted to follower unit, the sound to refuse receiving signal (3 beeps) is heard and the follower unit does not receive the signal.)

For FIX operation, both Header and follower unit perform the operation by itself. When wired remote controller is used, airflow direction can be changed on each unit by selecting the indoor unit.)

#### 4. TIMER lamp lights up only on the Header unit.

When the timer is set with wired remote controller, even the TIMER lamp on the Header unit will not light up.

## 7 HANDLING THE REMOTE CONTROLLER

### CAUTION

- The air conditioner will not operate if curtains, doors or other materials block the signals from the remote controller to the indoor unit.
- Prevent any liquid from falling into the remote controller.  
Do not expose the remote controller to direct sunlight or heat.
- If the infrared signal receiver on the indoor unit is exposed to direct sunlight, the air conditioner may not function properly.  
Use curtains to prevent the sunlight from reaching the receiver.
- If the room using the air conditioner has fluorescent lighting with electronic starters, signals may not be properly received. If you are planning to use such fluorescent lamps, consult your local dealer.
- If other electrical appliances react to the remote controller move these appliances or consult your local dealer.

### ■ Location of the remote controller

- Keep the remote controller where its signals can reach the receiver of the indoor unit (a distance of 7 m is allowed).
- When you select the timer operation, the remote controller automatically transmits a signal to the indoor unit at the specified time.  
If you keep the remote controller in a position that hinders proper signal transmission, a time lag of up to 15 minutes may occur.

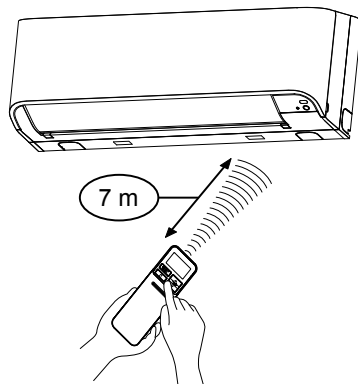

### ■ Remote controller holder

#### Installing the remote controller holder

- Before you actually install the remote controller holder on a wall or pillar, check whether the remote controller signals can be received by the indoor unit.

#### Mounting and removing the remote controller

- To mount the remote controller hold it parallel to the remote controller holder and push it in fully.  
To remove the remote controller slide the remote controller upwards and out from the holder.

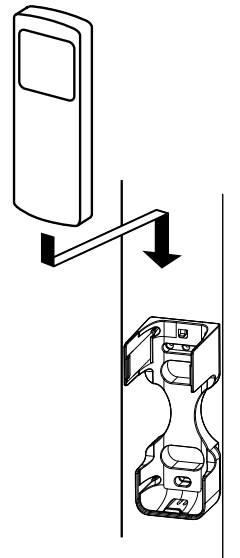







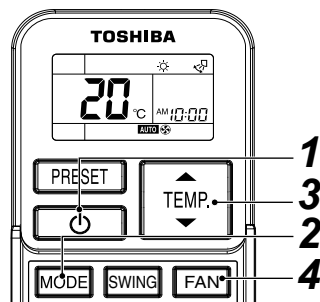







## 8 HOW TO USE REMOTE CONTROLLER

### ■ Cooling/heating/fan only operation

#### Start



- 1 START/STOP button** (  )  
Press this button to start the air conditioner.
  - 2 Mode select button (MODE)**  
Select Cool , Heat , or Fan only .
  - 3 Temperature button** (  )  
Set the desired temperature.  
When the air conditioner is in FAN ONLY operation, the temperature display is not indicated.
  - 4 Fan speed button (FAN)**  
Select one of **AUTO** , LOW , LOW+ ,  
MED , MED+ , HIGH .
- The  OPERATION lamp on the display panel of the indoor unit goes on. And operation starts after approximately 3 minutes. (If you select FAN ONLY mode, the unit will start immediately.)
  - The  : Fan only mode does not control temperature.
  - Fan speed **AUTO** is the same as HIGH .
- Therefore, perform only steps **1**, **2** and **4** to select this mode.

#### Stop

##### START/STOP button ( )

Press this button again to stop the air conditioner.





#### NOTE

When the indoor unit is operated together with a cooling only outdoor model outdoor unit,  appears on the remote controller but the heating operation is disabled.

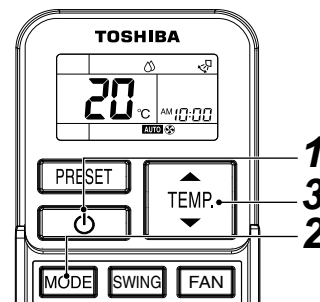
### ■ Dry operation

#### Start



- 1 START/STOP button** (  )  
Press this button to start the air conditioner.
  - 2 Mode select button (MODE)**  
Select Dry .
  - 3 Temperature button** (  )  
Set the desired temperature.
- The fan speed display indicates **AUTO**.
  - The  OPERATION lamp on the display panel of the indoor unit lights, and operation starts after approximately 3 minutes.

#### Stop

##### START/STOP button ( )

Press this button again to stop the air conditioner.

## Automatic operation (auto changeover)

This function is available only for use in combination with a heat recovery model outdoor unit. If this function is used with another model of outdoor unit, "A" (Auto) appears on the remote controller but the automatic operation is disabled.

### Start

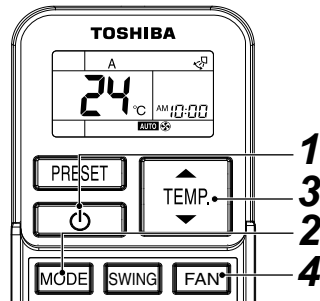

- 1 START/STOP button** ( )  
Press this button to start the air conditioner.
- 2 Mode select button (MODE)**  
Select A.
- 3 Temperature button** ( )  
Set the desired temperature.
- 4 Fan speed button (FAN)**  
Select one of **AUTO** **LOW** **LOW+** **MED** **MED+** **HIGH** .

- The OPERATION lamp on the display panel of the indoor unit lights.  
The operating mode is selected in accordance with the room temperature and operation starts after approximately 3 minutes.
- If the "A" mode is uncomfortable, you can select the desired conditions manually.

### Stop

**START/STOP button** ( )  
Press this button again to stop the air conditioner.

### CAUTION

#### Disagreement in operation mode

If you select AUTOMATIC OPERATION in a model with no auto-changeover (cooling/heating) control setting or if you select HEAT in a Cool Only model, lamp lights up and and lamps blink alternately with an alarm sound (pi, pi) from the air conditioner due to disagreement in operation mode. Change the operation mode with the MODE button on the wireless remote controller. This disagreement indication cannot be deleted by the wired remote controller.

## Timer operation

Use the wired remote controller for timer setting if it is also in use.

### ON timer and OFF timer

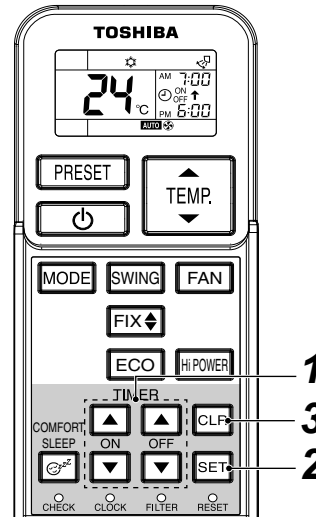

### Setting TIMER

- 1 ON/OFF TIMER button** ( or )  
Press the ON or OFF TIMER buttons as required.
  - The previous timer setting is displayed and flashes along with ON/OFF timer display.
 Set the timer to the desired time.  
Each press of the TIMER button changes the time in ten minute steps.  
Pressing the TIMER button continually changes the time in one hour step.
- 2 SET button**  
Press the SET button to set the timer.  
The timer time is indicated and the timer starts.

### Cancelling TIMER

- 3 CLR button**  
Press the CLR button to cancel the timer setting.

### CAUTION

- When you select the timer operation, the remote controller automatically transmits the timer signal to the indoor unit at the specified time. Therefore, keep the remote controller in a location where it can transmit the signal to the indoor unit properly. Otherwise, the time lag of up to 15 minutes will occur.
- If you do not press the SET button within 30 seconds after setting the time, the setting will be cancelled.

Once you select the timer operation mode, the settings are saved in the remote controller. Thereafter, the air conditioner will start operating under the same conditions when you simply press the ON/OFF button of the remote controller.

If the clock display is flashing, you cannot set the timer.

Follow the instructions in the section "SETTING THE CLOCK" and then set the timer.

### **Combined timer (Setting both ON and OFF timers simultaneously)**

#### **OFF timer → ON timer**

#### **(Operation → Stop → Operation)**



This feature is useful when you want to stop the air conditioner after you go to sleep, and start it again in the morning when you wake up or you return home.

Example:

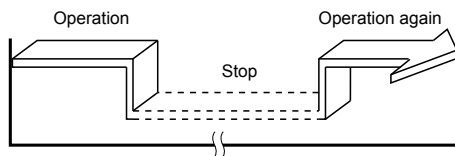
To stop the air conditioner and start it again next morning.



#### **▼ Setting combined TIMER**

1. Press the OFF TIMER  button to adjust the OFF timer.
2. Press the ON TIMER  button to adjust the ON timer.
3. Press the SET  button.

#### **ON timer → OFF timer**

#### **(Stop → Operation → Stop)**



You can use this setting to start the air conditioner when you wake up and stop it when you leave the house.

Example:

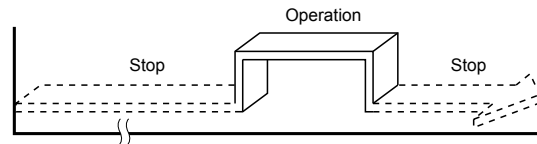
To start the air conditioner next morning and stop it.



#### **▼ Setting combined TIMER**









1. Press the ON TIMER  button to adjust the ON timer.
2. Press the OFF TIMER  button to adjust the OFF timer.
3. Press the SET  button.

- Either ON or OFF timer function which is closer to the current time, is activated first.
- If the same time is set for both ON and OFF timers, no timer operation is performed. Also, the air conditioner may stop operating.

### **Every day combined timer (setting both ON and OFF timer simultaneously and activate every day.)**

This feature is useful when you want to use combined timer at the same time every day.

#### **▼ Setting combined TIMER**

1. Press the ON TIMER  button to adjust the ON timer.
  2. Press the OFF TIMER  button to adjust the OFF timer.
  3. Press the SET  button.
  4. After step 3, an arrow mark ( or ) flashes for about 3 seconds and during this flashing, press the SET  button.
- During the every day timer is activating, both arrows (, ) are indicated.

### **Cancel the timer operation**

Press the CLR  button.

### **Clock display**

During the TIMER operation (ON-OFF, OFF-ON, OFF timer) clock display is disappeared so as to show the setting time. To see the present time, press SET button briefly and the present time is displayed about 3 seconds.

## ■ High power operation

### High power (Hi POWER)

- The Hi POWER (high power operation) mode automatically controls room temperature, airflow and operation mode so that the room is quickly cooled in summer and warmed in winter.

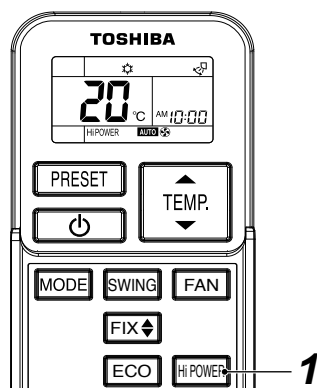

### Setting Hi POWER mode

#### 1 Hi POWER button



Press the Hi POWER button after starting any operation. At the same time, the "Hi POWER" mark on the remote controller is indicated.

### Cancelling Hi POWER mode

#### 1 Hi POWER button

Press the Hi POWER button once again. At the same time, the "Hi POWER" mark on the remote controller goes out.

### ⚠ CAUTION

- The Hi POWER mode cannot be activated in the  DRY and  FAN ONLY operation and when the ON TIMER operation is reserved.
- Hi POWER mode is not available for group control.  
When Hi POWER is transmitted to the Header indoor unit, the receiving sound is heard but the Hi POWER mode will not be performed. Please cancel the Hi POWER mode.

## ■ ECO operation

- The ECO mode provides ECO operating status by automatically control room temperature to save energy (except in DRY and FAN ONLY mode).

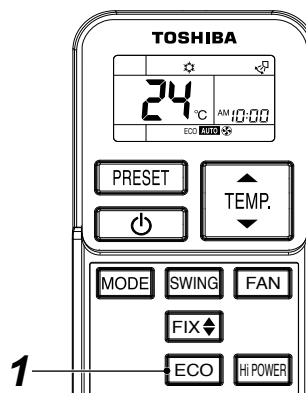

### Setting ECO mode

#### 1 ECO button



Press the ECO button after starting any operation. At the same time, the ECO mark is indicated.

### Cancelling ECO mode

#### 1 ECO button

Press the ECO button once again. At the same time, the ECO mark on the remote controller disappears.

### ⚠ CAUTION

The ECO mode cannot be activated in the  DRY and  FAN ONLY operation.

### NOTE

Cooling operation; the set temperature will increase automatically 1 degree/hour for 2 hours (maximum 2 degrees increase).

## ■ Preset Operation

Set your preferred operation mode for future use. The setting is memorized by the unit for future operation (except airflow direction).

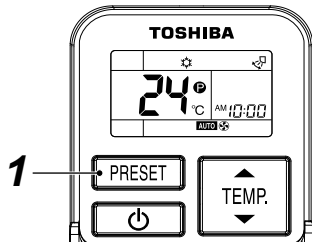

Select your preferred operation.

### 1 Press the PRESET button for 3 seconds to memorize the setting.

The **P** mark is displayed.

When you press this button next time, the memorized operation mode will be enabled.

## ■ Comfort sleep operation

COMFORT SLEEP mode is a OFF timer operation with automatic temperature and fan speed adjustment.

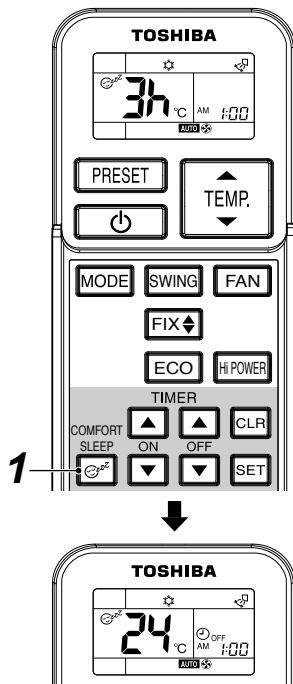

### 1 Press the COMFORT SLEEP button.

Select 1, 3, 5 or 9 hours for the OFF timer operation.

## ⚠ CAUTION

The COMFORT SLEEP mode is not enabled in the **DRY** or **FAN ONLY** operation.

## NOTE

- For the cooling operation, the set temperature will automatically increase 1 degree/hour for 2 hours (maximum 2 degrees increase). For the heating operation, the set temperature will decrease.
- During group control operation, the set temperature and the fan speed are not automatically adjusted. Only off timer function is activated.

## ■ Adjusting airflow direction

- Adjust the airflow direction properly. Otherwise, it might cause discomfort and make the room temperature uneven.
- Adjust the vertical airflow using the remote controller.
- Adjust the horizontal airflow manually.

### Adjust the vertical airflow

The air conditioner automatically adjusts the vertical airflow direction in accordance with the operating conditions when AUTO or A mode is selected.

#### To set the airflow direction you desire

Perform this function when the air conditioner is in operation.

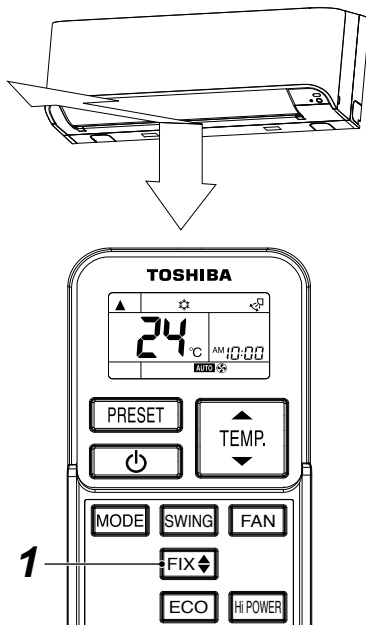

#### 1 FIX button

Keep pressing or pressing briefly the FIX button on the remote controller to move the louver in the desired direction.

- In subsequent operations, the vertical airflow is automatically set in the direction to which you adjusted the louver using the FIX button.

#### NOTE

Operating angle of vertical airflow louver will be different during cooling, dry and heating operation.

#### To automatically swing the airflow direction

Perform this function when the air conditioner is in operation.

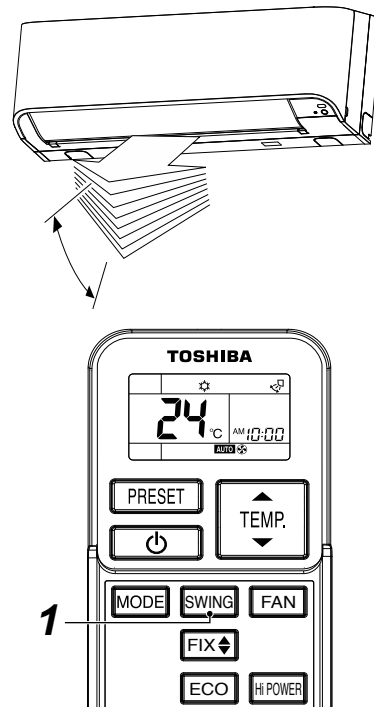

#### 1 SWING button

Press the SWING button on the remote controller.

- To stop the function, press the SWING button.



## CAUTION

- The FIX and SWING buttons will be disabled when the air conditioner is not in operation (including when the ON timer is set).
- Do not operate the air conditioner for long hours with the airflow direction set downward during the cooling or dry operation. Otherwise, condensation may occur on the surface of the vertical airflow louver and cause dew dripping.
- Do not move the vertical airflow louver manually. Always use the FIX button. If you move the louver manually, it may malfunction during operation. If the louver malfunctions, stop the air conditioner once, and restart.
- When the air conditioner is started immediately after it was stopped, the vertical airflow louver might not move for 10 seconds or so.
- Louver operation is limited when performing group control. (see page 16)

## ■ Adjust the horizontal airflow

### Preparation

- Take hold of the lever on the horizontal airflow louver and move them to adjust the airflow direction as required.
- You can adjust the airflow at the left, and right locations of the louver.

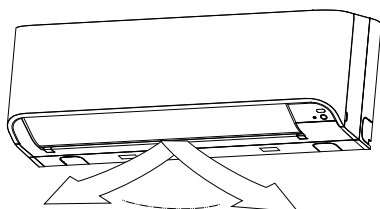

# 9 HINTS FOR ECONOMICAL OPERATION

## ■ Maintain room temperature at comfortable level

### Clean air filters

The clogged air filters impairs the performance of the air conditioner. Clean them once two weeks.

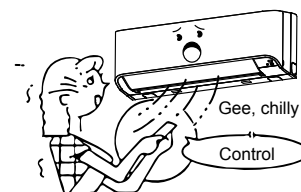

### Never open doors and windows more often than necessary

To keep cool or warm air in the room, never open doors and windows more often than necessary.

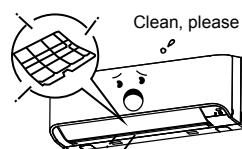

### Window curtains

In cooling, close the curtains to avoid direct sunlight.

In heating, close the curtains to keep the heat in.

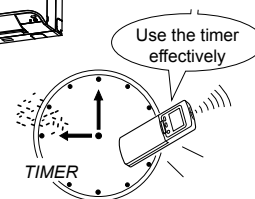

### Use the timer effectively

Set the timer for the desired operating time.

### Get uniform circulation of room air

Adjust airflow direction for even circulation of room air.

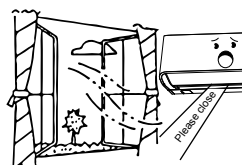
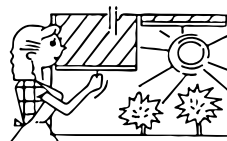

Blows upward

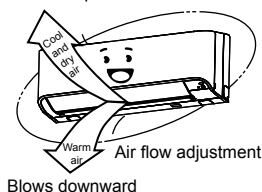

Blows downward

# 10 TEMPORARY OPERATION

## ■ TEMPORARY operation

This function is used to operate the unit temporarily in case you misplace the wireless remote controller or its batteries are exhausted.

- Push the [RESET] button once (less than 3 seconds) to start the air conditioner.
- The last operation conducted with the wireless remote controller will be performed. (When wireless remote controller is not used, models with the auto-changeover (cooling/heating) function perform "A" operation, and those without the function perform cooling operation (set temperature: 24 °C, fan: HIGH).)

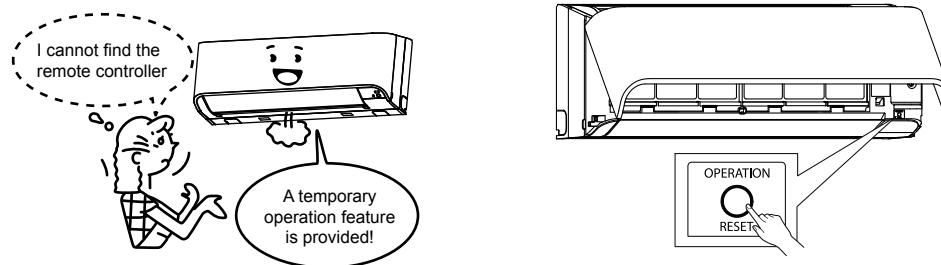

### ⚠ CAUTION

Continuous pressing of the [RESET] button for 10 seconds and above will start the forced cooling operation.

(This will impose burden on the air conditioner. Do not perform this for the purposes other than test run.)

In this time all indicators of indoor unit go on.

# 11 MAINTENANCE

## ⚠ WARNING

Before you clean the air conditioner, be sure to turn off the circuit breaker or main power switch.

### ■ Cleaning of indoor unit and remote controller

## ⚠ CAUTION

- Use a dry cloth to wipe the indoor unit and remote controller.
- A cloth dampened with cold water may be used on the indoor unit if it is very dirty.
- Never use a damp cloth on the remote controller.
- Do not use a chemically-treated duster for wiping or leave such materials on the unit for long. It may damage or fade the surface of the unit.
- Do not use benzine, thinner, polishing powder, or similar solvents for cleaning. These may cause the plastic surface to crack or deform.

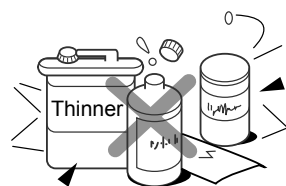

#### If you will not use the unit for at least 1 month

1. Operate the air conditioner in FAN ONLY mode for about half a day to dry the inside of the unit.
2. Stop the air conditioner and turn off the main power switch.
3. Remove the batteries from the remote controller.

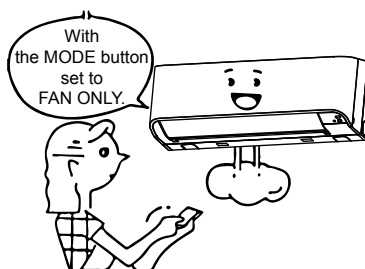

#### Check before operation

## ⚠ CAUTION

- Check that the air filters are installed.
- Check that the air outlet or inlet of the outdoor unit is not blocked.

## ■ Cleaning the air filter

Clean the air filters every 2 weeks. If the air filters are covered with dust, the performance of the air conditioner will deteriorate.

Clean the air filters as often as possible.

1. Open the air inlet grille.  
Lift the air inlet grille up to the horizontal position.

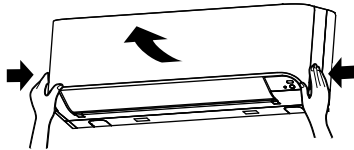

2. Take hold of the left and right handles of the air filter and lift it up slightly, then pull it downward to take it out from the filter holder.

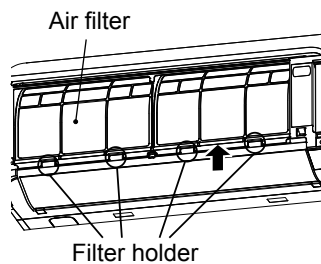

3. Use a vacuum cleaner to remove the dust from the filters or wash them with water.  
If you wash the air filters, dry them in the shade.

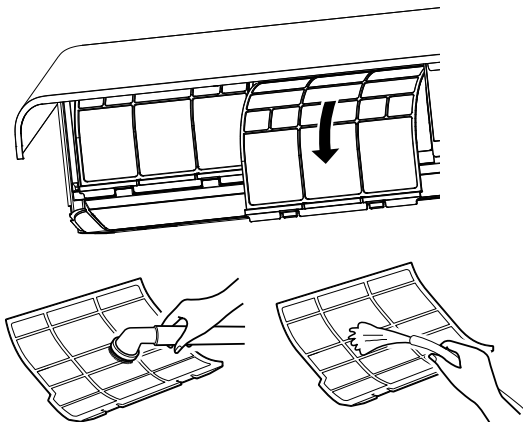

4. Insert the upper portion of air filter confirming to fit its right and left edges on the indoor unit until it is firmly set.

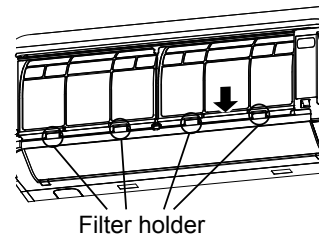
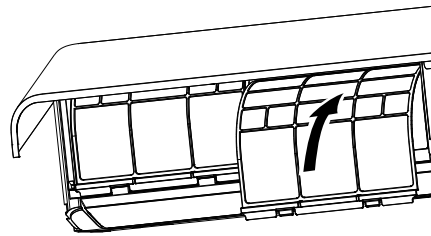

5. Close the air inlet grille.

## ■ Cleaning the air inlet grille

1. Remove the air inlet grille.  
Hold the two sides of the air inlet grille and open upwards.  
Move the centre arm to the left and remove the grille.

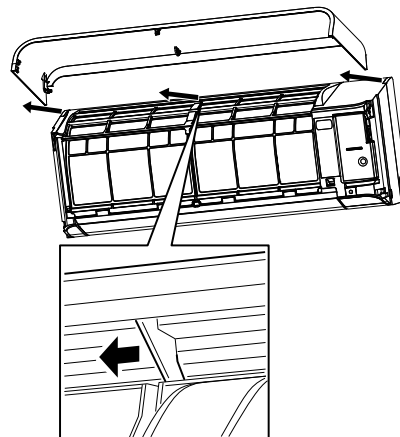

2. Wash it with water using a soft sponge or towel.  
(Do not use metallic scrubbing brush or other hard brushes.)
  - Use of such hard objects will cause scratches on the surface of the grille, and the metal coating to peel off.
  - If very dirty, clean the air inlet grille with a neutral detergent for kitchen use, and rinse it off with water.

3. Wipe out water from the air inlet grille and dry it.
4. Fit the left and right arms of the air inlet grille to the shafts on the two sides of the air conditioner and push in completely, and then push in the centre arm.

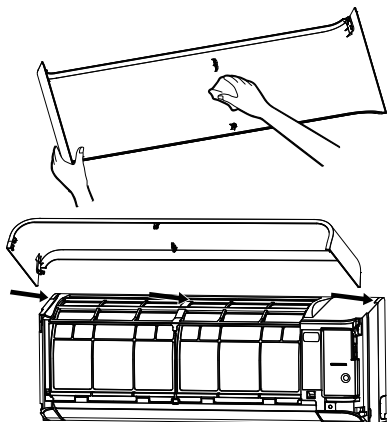

5. Check that the centre arm has been completely inserted and close the air inlet grille.
  - Push the arrow locations (Three) at the bottom of the air inlet grille to check whether the grille is completely closed.

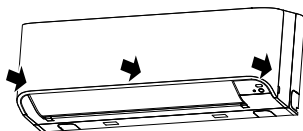

# 12 TROUBLES AND CAUSES

For contents of the outdoor unit, combinations, etc., refer to the owner's manual supplied with the outdoor unit.

## ⚠ CAUTION

If any of the following conditions occur, stop the air conditioner immediately, set to off the main power switch and contact the dealer:

- Switch operation are erratic.
- The main power fuse often blows out, or the circuit breaker is often activated.
- Foreign matter or water has fallen inside the air conditioner.
- Any other unusual condition is observed.
- Abnormal display appears on the remote controller display while using wired remote controller.

**Before you ask for servicing or repairs, check the following points.**

### ▼ Recheck Inoperative

- The power main switch is turned off. (Indoor)
- The circuit breaker is activated to cut off the power supply.
- The main power fuse has blown out.
- Stoppage of electric current.
- The batteries in the remote controller are exhausted.
- ON TIMER is set.
- Signal is sent to the follower indoor unit with the remote controller. (see page 17)
- Operation of the indoor unit is limited by the wired remote controller that is controlling some other system. (When signal is transmitted, warning sound (5 beeps) will be heard.)
- Disagreement in operation mode occurred. (When the operation mode disagrees, the "○ OPERATION" lamp lights up, and the "⌚ TIMER" and "☀ Preheat/Defrost" lamps blink alternately with an alarm sound.) (see page 12 )



### Poor cooling or heating performance

- Doors or windows are opened.
- The air filter is clogged with dust.
- The louver is not at the correct position.
- The fan speed is set to low.
- The air conditioner is set in the QUIET or  DRY mode.
- The set temperature is too high. (In cooling operation)
- The set temperature is too low. (In heating operation)
- (Only when the air is not cooled even during cooling operation)  
When another indoor unit in the same system is heating.

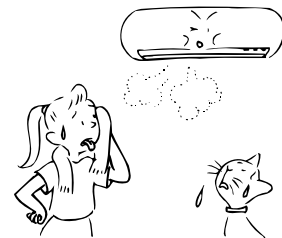

▼ **These are not failures.**

**The back of indoor unit is dewed.**

- Dewdrops on the back of the indoor unit are automatically collected and drained out.

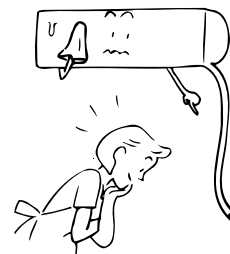

**Indoor unit or outdoor unit makes a strange noise.**

- When temperature sharply changes, the indoor or outdoor unit occasionally makes a strange noise because of expansion/contraction of parts or change of refrigerant flow.

**The room air is smelly.**

**A bad odor comes from the air conditioner.**

- Smells impregnated in the wall, carpet, furniture, clothing, or furs, are coming out.

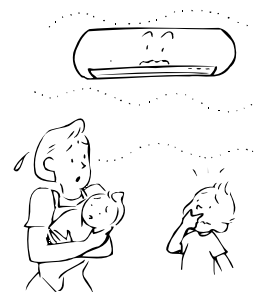

**Louver does not work in the FIX or SWING mode.**

- The FIX and SWING modes are restricted under the group control. (see page 16)

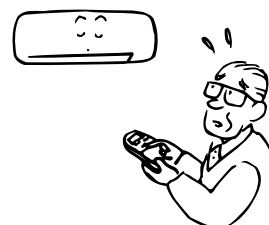

**Fan and louvers of the indoor unit moves when the unit is not operated.**

- When the other indoor unit(s) is operating within the system, a fan of switched off indoor unit may temporary operate.









# Toshiba Carrier (Thailand) Co., Ltd.

144 / 9 Moo 5, Bangkadi Industrial Park, Tivanon Road, Tambol Bangkadi, Amphur Muang, Pathumthani 12000, Thailand



1121250218